

Schüco Corona CT 70 AS Classic TopAlu

Systemschnitt 1:1
 System cross section 1:1
 Coupe 1:1
 Sección del sistema 1:1

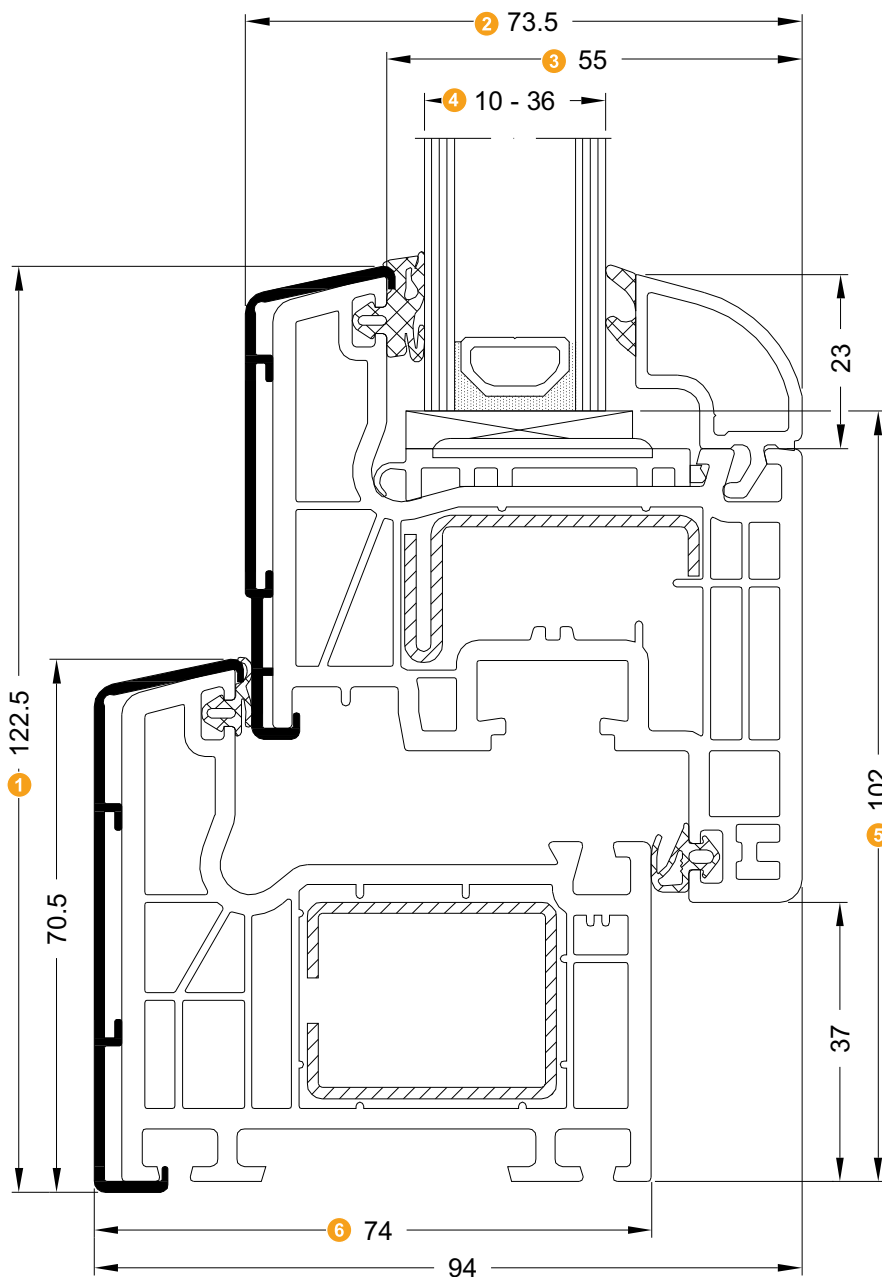

- | | |
|--|--|
| <p>1 Ansichtsbreite
 Face width
 Masse vue
 Anchura visual</p> | <p>4 Glasdicke
 Glass thickness
 Possibilité de vitrage
 Grosor acristalamiento</p> |
| <p>2 Flügelrahmen Bautiefe
 Basic depth of vent frame
 Profondeur d'ouvrant
 Profundidad de la hoja</p> | <p>5 Glasabzugsmaß
 Glass deduction
 Côte de déduction de vitrage
 Medida para descuento del vidrio</p> |
| <p>3 Glasfalzbreite
 Glazing rebate width
 Profondeur de feuillure de vitrage
 Anchura del galce</p> | <p>6 Blendrahmen Bautiefe
 Basic depth of outer frame
 Profondeur de dormant
 Profundidad de marco</p> |

Corona CT 70 AS Rondo TopAlu

Systemschnitt 1:2
 System cross-section 1:2
 Coupe 1:2
 Sección del sistema 1:2

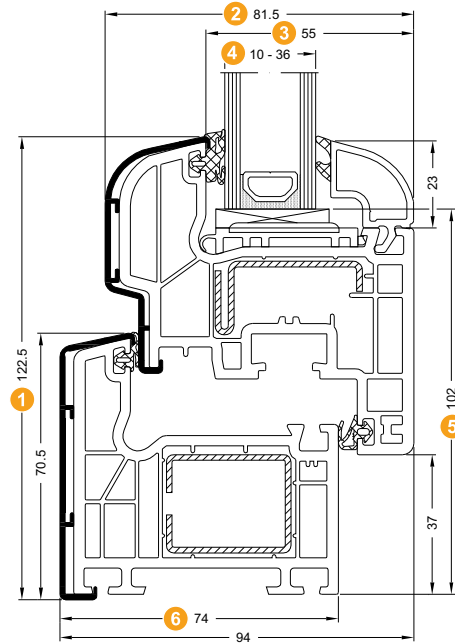

Corona CT 70 AS Cava TopAlu

Systemschnitt 1:2
 System cross-section 1:2
 Coupe 1:2
 Sección del sistema 1:2

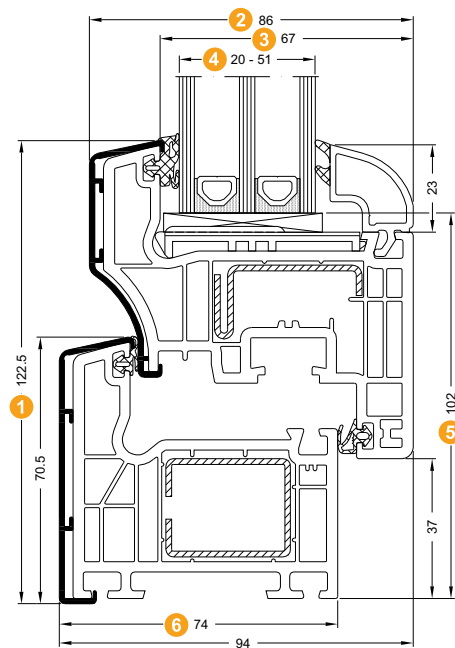

TopAlu

für Eckausbildung Gehrung 45° und „Stumpfer Stoß“
 For corner construction with 45° mitre joint and „butt joint“
Assemblage en coupe d'onglet et coupe droite
 Para formación de esquinas en inglete de 45° y „corte recto“

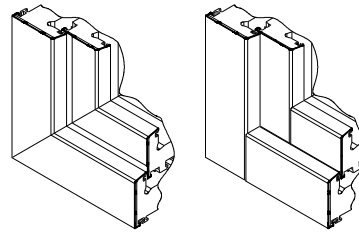

TopAlu 68 13164200

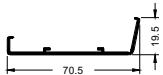

100



18596...
18865...
19021...



28648700



22613700

TopAlu 78 13164300

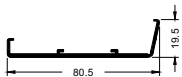

110



18597...
18852...
18864...



28648700



22613700

TopAlu 88 13164400

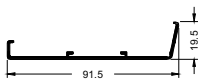

120



18819...



28648700



22613700

Eckausbildung Gehrung 45°
 Corner construction with 45° mitre joint
Assemblage en coupe d'onglet
 Formación de esquinas en inglete de 45°

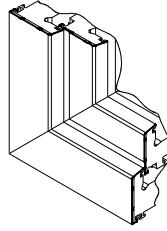

TopAlu 78

nach außen öffnend • outward-opening
Ouvrant vers l'extérieur • Apertura exterior

13297400

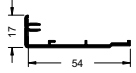

77

19074...



191

19034...



TopAlu 78 Rondo 13297000

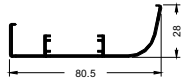

126

18597...



28648700



22613700



308

18852...

18864...

TopAlu 88 13299800

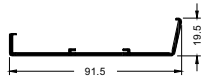

124

18622...



28648700



22613700



259

TopAlu 45 11550700

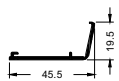

68

18570...



28618600



138

18899...

19011...

Eckausbildung „Stumpfer Stoß“
 Corner construction „butt joint“
 Assemblage en coupe droite
 Formación de esquinas „corte recto“

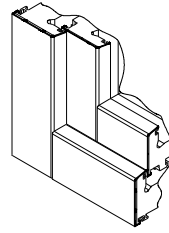

TopAlu 83 Classic
 13292200

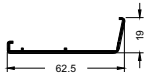

88



18562...

18866...



175

TopAlu 103 Classic
 13292300

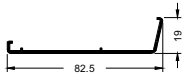

108



18563...



216

TopAlu 120 Classic
 11554500

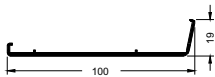

125



19108



249

Eckausbildung Gehrung 45°
 Corner construction with 45° mitre joint
 Assemblage en coupe d'onglet
 Formación de esquinas en inglete de 45°

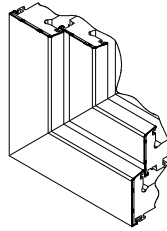

TopAlu 51 Classic
 11556000

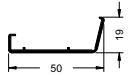

75

19153...



28649000



150

TopAlu 71 Classic
 11551600

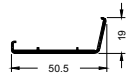

75

19053...



28625100



150

TopAlu 63 Classic
 11556200

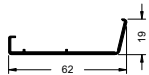

75

18898...



28649000



22613700



150

TopAlu 83 Classic
 13164500

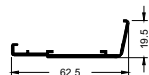

88

18562...



28067800



22613700



192

18866...

TopAlu 83 Classic
 11556300

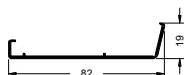

75

19154...



28649000



22613700



150

TopAlu 103 Classic
 13164600



108

18563...



28067900



22613700



237

TopAlu 120 Classic
 11554400

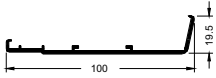

126



269



19108...
 19271...



28639700



22613700

TopAlu 120 Classic
 nach außen öffnend • outward-opening
 Ouvrant vers l'extérieur • Apertura exterior
 11554600

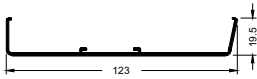

162



334



19109...



28639700



22613700

verfügbar ab 10.2011
 available from 10.2011
 disponible à partir de 10.2011
 disponible a partir 10.2011

TopAlu 71 Rondo
 11557400

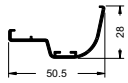

87



19196...



28648900



187

TopAlu 83 Rondo
 13164900

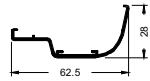

99



18575...
 18867...



28648900



22613800



211

TopAlu 103 Rondo
 13165000

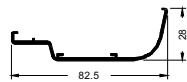

119



18620...



28648900



22613700



251

TopAlu 120 Rondo
 11555100

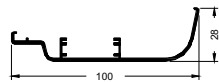

135



19108...



28639700



22613700



335

TopAlu 83 Cava
 13165100

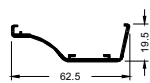

93



18689...
 18868...



28068400



22613800



201

TopAlu 103 Cava
 13165200

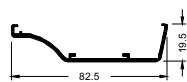

113



18621...



28068500



22613700



241

flächenbündig
 Flush-fitted
A fleur
 Enrasados

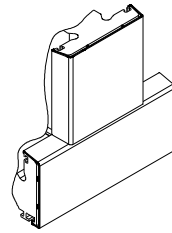

TopAlu 91
 13295700

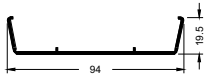

130

18584...

18869...



264

18594...

18514...

19012...

TopAlu 110
 13165400

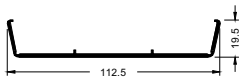

148

18848...

18849...



300

19048...

flächenversetzt
 Rebated
 En saillie
 Con resalte

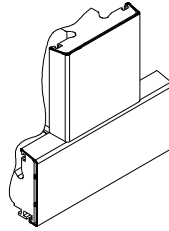

TopAlu 70
 13165500

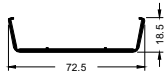

106

18520...
 18513...



209

TopAlu 91
 13165300

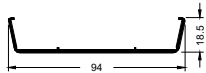

127

18584...
 18869...



252

18594...
 18514...
 19012...

TopAlu 110
 13292100

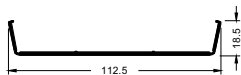

146

18848...
 18849...



290

19048...

TopAlu 147
 13293200

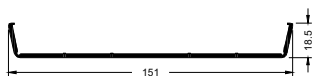

184

18515...



366

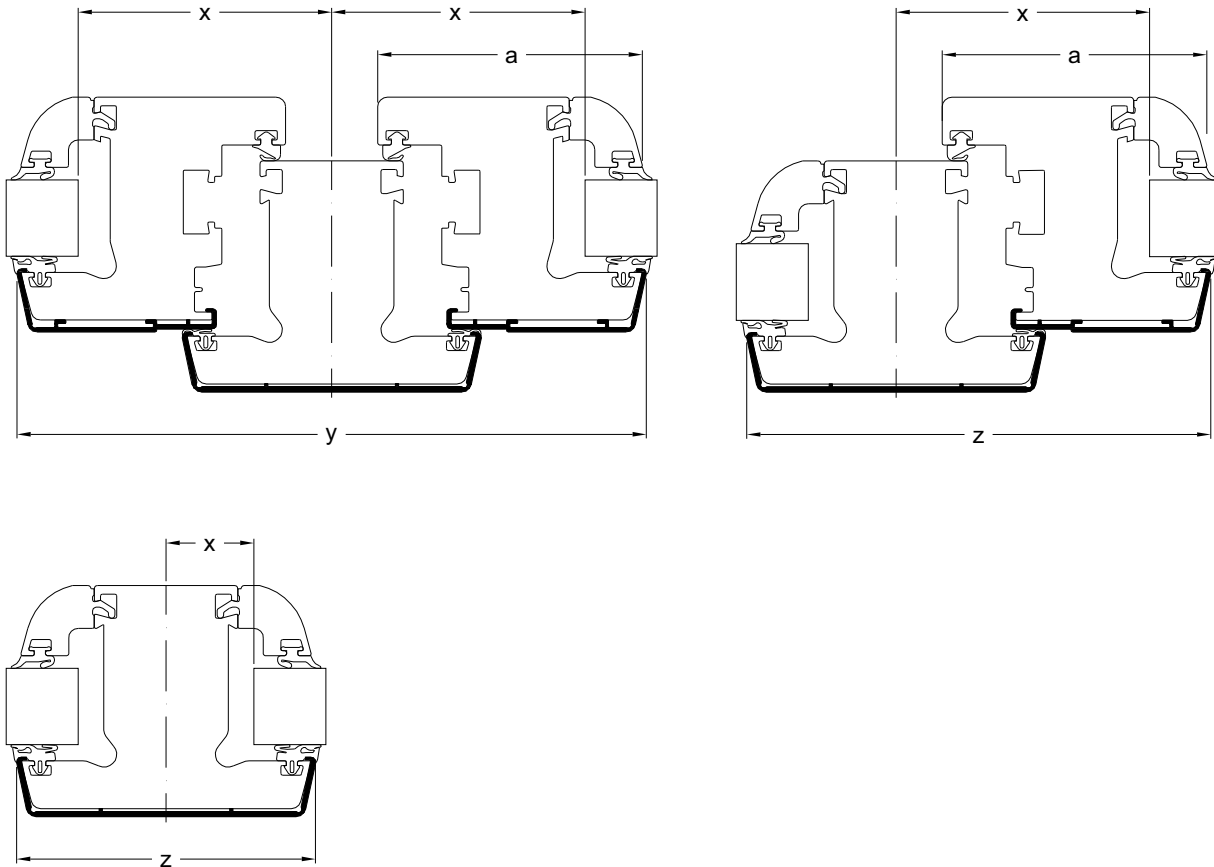

T-Profil Ansichtsbreite • T-profile face width
 Masse vue de traverses • Anchura visual del perfil en T

91 mm (93,5 mm)

Flügelprofil Gesamtansichtsmaß Total face width of vent profile Masse vue de l'ouvrant Dimensiones generales del perfil de hoja	a	ohne Flügelprofil Without vent profile Sans profilé d'ouvrant sin perfil de hoja	71 mm	73 mm	83 mm	103 mm	120 mm
Glasabzugsmaß Glass deduction Côte de déduction de vitrage Medida para descuento del vidrio	x	27,5	67,5	69,5	79,5	99,5	116,5
Ansichtsbreite TopAlu TopAlu face width Masse vue en TopAlu Anchura visual TopAlu	y	—	131,5	135,5	145,5	165,5	182,5
	z	93,5	174,5	177,5	197,5	237,5	271,5

110 mm (112,5 mm)

Flügelprofil Gesamtansichtsmaß Total face width of vent profile Masse vue de l'ouvrant Dimensiones generales del perfil de hoja	a	ohne Flügelprofil Without vent profile Sans profilé d'ouvrant sin perfil de hoja	71 mm	73 mm	83 mm	103 mm	120 mm
Glasabzugsmaß Glass deduction Côte de déduction de vitrage Medida para descuento del vidrio	x	37	77	79	89	109	126
Ansichtsbreite TopAlu TopAlu face width Masse vue en TopAlu Anchura visual TopAlu	y	—	150,5	154,5	164,5	184,5	201,5
	z	112,5	193,5	196,5	216,5	256,5	290,5

TopAlu 34
 11550900

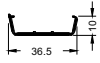

56

19056...

28602900



113

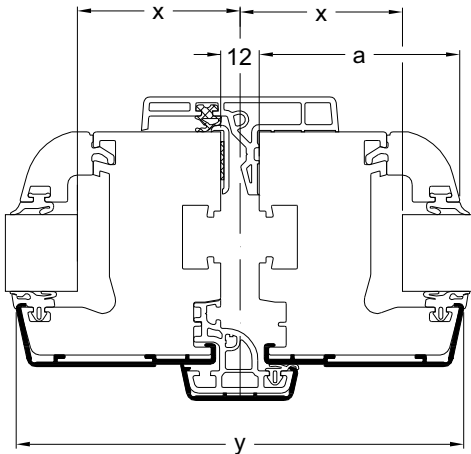

Alu-Stulpprofil 34 • Aluminium meeting stile profile 34
 Profilé de battement 34 en alu • Inversora de aluminio 34
 11555900

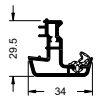

100

28639500



168

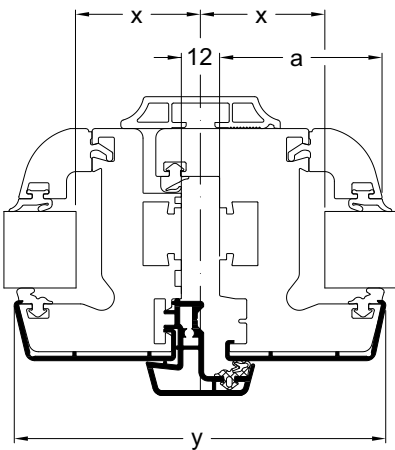

Stulpprofil Ansichtsweite • Face width of double-vent profile
 Masse vue du profilé à battement • Anchura visual del perfil inversor

34 mm (36,5 mm)

Flügelprofil Gesamtansichtsmaß Total face width of vent profile Masse vue de l'ouvrant Dimensiones generales del perfil de hoja	a+20	ohne Flügelprofil Without vent profile Sans profilé d'ouvrant sin perfil de hoja	71 mm	73 mm	83 mm	103 mm	120 mm
Glasabzugsmaß Glass deduction Côte de déduction de vitrage Medida para descuento del vidrio	x	—	39	41	51	—	—
Ansichtsweite TopAlu TopAlu face width Masse vue en TopAlu Anchura visual TopAlu	y	—	116,5	120,5	140,5	—	—

TopAlu 53
 13165600

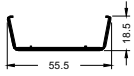

89

18518...

23744400



175

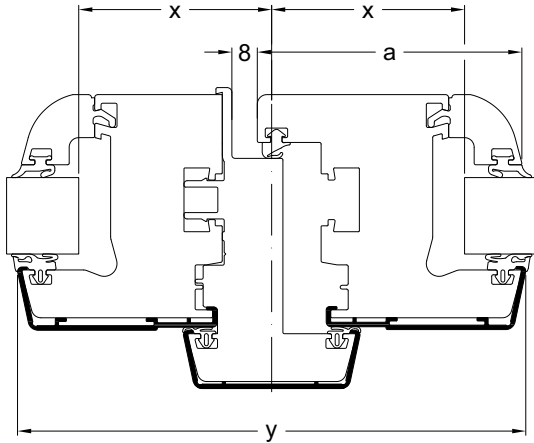

Stulpprofil Ansichtsweite • Face width of double-vent profile
 Masse vue du profilé à battement • Anchura visual del perfil inversor

53 mm (55,5 mm)

Flügelprofil Gesamtansichtsmaß Total face width of vent profile Masse vue de l'ouvrant Dimensiones generales del perfil de hoja	a	ohne Flügelprofil Without vent profile Sans profilé d'ouvrant sin perfil de hoja	71 mm	73 mm	83 mm	103 mm	120 mm
Glasabzugsmaß Glass deduction Côte de déduction de vitrage Medida para descuento del vidrio	x	—	48,5	50,5	60,5	80,5	97,5
Ansichtsweite TopAlu TopAlu face width Masse vue en TopAlu Anchura visual TopAlu	y	—	135,5	139,5	159,5	199,5	233,5

56 mm (58,5 mm)

Flügelprofil Gesamtansichtsmaß Total face width of vent profile Masse vue de l'ouvrant Dimensiones generales del perfil de hoja	a	ohne Flügelprofil Without vent profile Sans profilé d'ouvrant sin perfil de hoja	71 mm	73 mm	83 mm	103 mm	120 mm
Glasabzugsmaß Glass deduction Côte de déduction de vitrage Medida para descuento del vidrio	x	—	50,0	52,0	62,0	82,0	99,0
Ansichtsweite TopAlu TopAlu face width Masse vue en TopAlu Anchura visual TopAlu	y	—	138,5	142,5	162,5	202,5	236,5

TopAlu 70
 13165500

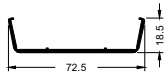

18636...
 18574...

23744600

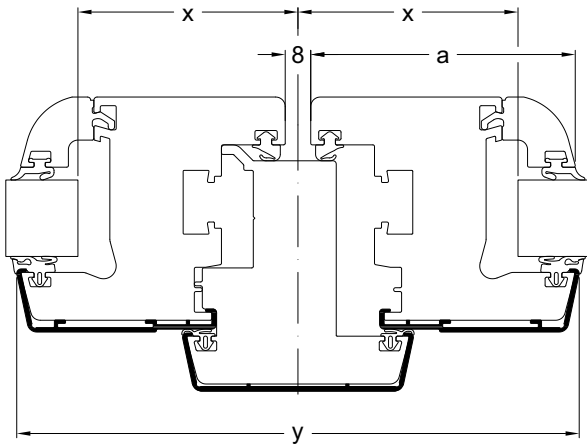

Stulpprofil Ansichtsbreite • Face width of double-vent profile
Masse vue du profilé à battement • Anchura visual del perfil inversor

70 mm (72,5 mm)

Flügelprofil Gesamtansichtsmaß Total face width of vent profile <i>Masse vue de l'ouvrant</i> Dimensiones generales del perfil de hoja	a	ohne Flügelprofil Without vent profile <i>Sans profilé d'ouvrant</i> sin perfil de hoja	71 mm	73 mm	83 mm	103 mm	120 mm
Glasabzugsmaß Glass deduction <i>Côte de déduction de vitrage</i> Medida para descuento del vidrio	x	—	57,0	59,0	69,0	89,0	106,0
Ansichtsbreite TopAlu TopAlu face width <i>Masse vue en TopAlu</i> Anchura visual TopAlu	y	—	152,5	156,5	176,5	216,5	250,5